

**ASUA30TLAV2**  
**ASUA36TLAV2**

## **INSTALLATION MANUAL**

INDOOR UNIT (Wall Mounted Type)

For authorized service personnel only.

## **MANUEL D'INSTALLATION**

UNITÉ INTÉRIEURE (Type montage mural)

Pour le personnel agréé uniquement.

## **MANUAL DE INSTALACIÓN**

UNIDAD INTERIOR (Tipo montado en pared)

Únicamente para personal de servicio autorizado.

English

Français

Español



# INSTALLATION MANUAL

PART No. 9373370475

VRF system indoor unit (Wall mounted type)

## Contents

<b>1. SAFETY PRECAUTIONS</b> .....	<b>1</b>
1.1. IMPORTANT! Please read before starting .....	1
1.2. SPECIAL PRECAUTIONS .....	1
<b>2. ABOUT THIS PRODUCT</b> .....	<b>2</b>
2.1. Precautions for using R410A refrigerant .....	2
2.2. Special tools for R410A .....	2
2.3. Accessories .....	2
2.4. Optional parts .....	2
2.5. About unit of the length .....	2
<b>3. INSTALLATION WORK</b> .....	<b>3</b>
3.1. Selecting an installation location .....	3
3.2. Installation dimension .....	3
3.3. Installing the unit .....	3
<b>4. PIPE INSTALLATION</b> .....	<b>5</b>
4.1. Selecting the pipe material .....	5
4.2. Pipe requirement .....	5
4.3. Flare connection (pipe connection) .....	5
<b>5. ELECTRICAL WIRING</b> .....	<b>6</b>
5.1. Electrical requirement .....	6
5.2. Wiring method .....	6
5.3. Unit wiring .....	7
5.4. Wiring .....	7
5.5. Optional parts wiring .....	8
5.6. External input and external output (optional parts) .....	9
<b>6. FIELD SETTING</b> .....	<b>10</b>
6.1. Setting the address .....	10
6.2. Custom code setting .....	11
6.3. Function setting .....	11
<b>7. FINISHING</b> .....	<b>13</b>
7.1. Connection pipe, cable and drain hose .....	13
<b>8. FRONT PANEL REMOVAL AND INSTALLATION</b> .....	<b>13</b>
8.1. Intake grill removal and installation .....	13
8.2. Front panel removal .....	13
8.3. Front panel installation .....	13
<b>9. TEST RUN</b> .....	<b>14</b>
9.1. Test run using Outdoor unit (PCB) .....	14
9.2. Test run using remote controller .....	14
<b>10. CHECK LIST</b> .....	<b>14</b>
<b>11. ERROR CODES</b> .....	<b>14</b>

## 1. SAFETY PRECAUTIONS

### 1.1. IMPORTANT! Please read before starting

This air conditioning system meets strict safety and operating standards. As the installer or service person, it is an important part of your job to install or service the system so it operates safely and efficiently.

For safe installation and trouble-free operation, you must:

- Carefully read this instruction booklet before beginning.
- Follow each installation or repair step exactly as shown.
- Observe all local, state, and national electrical codes.
- Pay close attention to all danger, warning, and caution notices given in this manual.

**WARNING:** This symbol refers to a hazard or unsafe practice which can result in severe personal injury or death.

**CAUTION:** This symbol refers to a hazard or unsafe practice which can result in personal injury and the potential for product or property damage.

- Hazard alerting symbols



: Electrical



: Safety/alert

#### If Necessary, Get Help

These instructions are all you need for most installation sites and maintenance conditions. If you require help for a special problem, contact our sales/service outlet or your certified dealer for additional instructions.

#### In Case of Improper Installation

The manufacturer shall in no way be responsible for improper installation or maintenance service, including failure to follow the instructions in this document.

## 1.2. SPECIAL PRECAUTIONS

### When Wiring

**ELECTRICAL SHOCK CAN CAUSE SEVERE PERSONAL INJURY OR DEATH. ONLY A QUALIFIED, EXPERIENCED ELECTRICIAN SHOULD ATTEMPT TO WIRE THIS SYSTEM.**

- Do not supply power to the unit until all wiring and tubing are completed or reconnected and checked.
- Highly dangerous electrical voltages are used in this system. Carefully refer to the wiring diagram and these instructions when wiring. Improper connections and inadequate earthing (grounding) can cause accidental injury or death.
- Earth (Ground) the unit following local electrical codes.
- Connect all wiring tightly. Loose wiring may cause overheating at connection points and a possible fire hazard.

### When Transporting

Be careful when picking up and moving the indoor and outdoor units. Get a partner to help, and bend your knees when lifting to reduce strain on your back. Sharp edges or thin aluminum fins on the air conditioner can cut your fingers.

### When Installing...

#### ...In a Ceiling or Wall

Make sure the ceiling/wall is strong enough to hold the unit's weight. It may be necessary to construct a strong wood or metal frame to provide added support.

#### ...In a Room

Properly insulate any tubing run inside a room to prevent "sweating" that can cause dripping and water damage to walls and floors.

#### ...In an Area with High Winds

Securely anchor the outdoor unit down with bolts and a metal frame. Provide a suitable air baffle.

#### ...In a Snowy Area (for Heat Pump-type Systems)

Install the outdoor unit on a raised platform that is higher than drifting snow.

### When Connecting Refrigerant Tubing

- Keep all tubing runs as short as possible.
- Use the flare method for connecting tubing.
- Apply refrigerant lubricant to the matching surfaces of the flare and union tubes before connecting them, then tighten the nut with a torque wrench for a leak-free connection.
- Check carefully for leaks before opening the refrigerant valves.

### When Servicing

- Turn the power OFF at the main circuit breaker panel before opening the unit to check or repair electrical parts and wiring.
- Keep your fingers and clothing away from any moving parts.
- Clean up the site after you finish, remembering to check that no metal scraps or bits of wiring have been left inside the unit being serviced.
- After installation, explain correct operation to the customer, using the operating manual.

#### DANGER

Never touch electrical components immediately after the power supply has been turned off. Electrical shock may occur. After turning off the power, always wait 5 minutes or more before touching electrical components.

- Be sure to read this Manual thoroughly before installation.
- The warnings and precautions indicated in this Manual contain important information pertaining to your safety. Be sure to observe them.
- Hand this Manual, together with the Operating Manual to the customer.
- Request the customer to keep them on hand for future use, such as for relocating or repairing the unit.

#### WARNING

Request your dealer or a professional installer to install the unit in accordance with this Manual.

An improperly installed unit can cause serious accidents such as water leakage, electric shock, or fire.

If the unit is installed in disregard of the instructions in the Installation Manual, it will void the manufacturer's warranty.

Do not turn ON the power until all work has been completed. Turning ON the power before the work is completed can cause serious accidents such as electric shock or fire.

If refrigerant leaks while work is being carried out, ventilate the area. If the refrigerant comes in contact with a flame, it produces a toxic gas.

Installation must be performed in accordance with the requirement of NEC (National Electrical Code) and CEC (Canadian Electrical Code) by authorized personnel only.

Except for EMERGENCY, never turn off main as well as sub breaker of the indoor units during operation. It will cause compressor failure as well as water leakage. First, stop the indoor unit by operating the control unit, converter or external input device and then cut the breaker.

Make sure to operate through the control unit, converter or external input device. When the breaker is designed, locate it at a place where the users cannot start and stop in the daily work.

Cancer and Reproductive Harm - [www.P65Warnings.ca.gov](http://www.P65Warnings.ca.gov)

## 2. ABOUT THIS PRODUCT

### 2.1. Precautions for using R410A refrigerant

#### ⚠ WARNING

Do not introduce any substance other than the prescribed refrigerant into the refrigeration cycle. If air enters the refrigeration cycle, the pressure in the refrigeration cycle will become abnormally high and cause the piping to rupture.

If there is a refrigerant leak, make sure that it does not exceed the concentration limit. If a refrigerant leak exceeds the concentration limit, it can lead to accidents such as oxygen starvation.

Do not touch refrigerant that has leaked from the refrigerant pipe connections or other area. Touching the refrigerant directly can cause frostbite.

If a refrigerant leak occurs during operation, immediately vacate the premises and thoroughly ventilate the area. If the refrigerant comes in contact with a flame, it produces a toxic gas.

### 2.2. Special tools for R410A

#### ⚠ WARNING

To install a unit that uses R410A refrigerant, use dedicated tools and piping materials that have been manufactured specifically for R410A use. Because the pressure of R410A refrigerant is approximately 1.6 times higher than the R22, failure to use dedicated piping material or improper installation can cause rupture or injury. Furthermore, it can cause serious accidents such as water leakage, electric shock, or fire.









Tool name	Contents of change for R22 tool
Gauge manifold	Pressure is huge and cannot be measured with a conventional (R22) gauge. To prevent erroneous mixing of other refrigerants, the diameter of each port has been changed. It is recommended to use a gauge manifold with a high pressure display range 500 microns to 768 psi (-0.1 to 5.3 MPa) and a low pressure display range 500 microns to 551 psi (-0.1 to 3.8 MPa).
Charging hose	To increase pressure resistance, the hose material and base size were changed.
Vacuum pump	A conventional (R22) vacuum pump can be used by installing a vacuum pump adapter. <ul style="list-style-type: none"> <li>A conventional vacuum pump can be used by installing a vacuum pump adapter.</li> <li>Be sure that the pump oil does not back flow into the system. Use one capable for vacuum suction of 500 microns (-100.7 kPa).</li> </ul>
Gas leakage detector	Special gas leakage detector for HFC refrigerant R410A.

## 2.3. Accessories

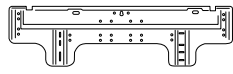
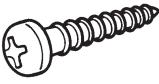
#### ⚠ WARNING

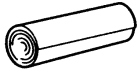
For installation purposes, be sure to use the parts supplied by the manufacturer or other prescribed parts. The use of non-prescribed parts can cause serious accidents such as the unit falling, water leakage, electric shock, or fire.

- The following installation parts are furnished. Use them as required.
- Keep the Installation Manual in a safe place and do not discard any other accessories until the installation work has been completed.

Name and Shape	Q'ty	Application
Operating Manual 	1	
Installation Manual 	1	(This book)
Wall hook bracket 	1	For indoor unit installation.
Tapping screw (M4 × 25 mm) 	8	For wall hook bracket installation.
Drain hose Insulation 	1	For installing drain hose
Cloth tape 	1	For indoor unit installation.
Cable tie 	(30/36 model) 2	For transmission and remote controller cable binding.
Air cleaning filter 	(30/36 model) 2	For installation, refer to the "CLEANING AND CARE" in the operating manual.
Air cleaning filter frame 	(30/36 model) 2	

### 2.4. Optional parts

Description	Model	Application
External connect kit	UTY-XWZXZC	For output function (Output terminal / CNB01)
	UTY-XWZXZB	For control input function (Apply voltage terminal / CNA01)
	UTY-XWZXZD	For control input function (Dry contact terminal / CNA02)
	UTY-XWZXZ7	For forced thermostat off function (Apply voltage terminal / CNA03)
	UTY-XWZXZE	For forced thermostat off function (Dry contact terminal / CNA04)
Wireless LAN adapter	UTY-TFSXZ*	For wireless LAN control.
MODBUS® convertor	UTY-VMSX	For connecting a single indoor unit system to the Modbus® network.
External power supply unit	UTZ-GXXA	Supply power to the indoor unit PCB when the indoor unit is turned off to prevent errors.

### 2.5. About unit of the length

This product is manufactured to metric units and tolerances. United States customary units are provided for reference only. In cases where exact dimensions and tolerances are required, always refer to metric units.

### 3. INSTALLATION WORK

Correct initial installation location is important because it is difficult to move unit after it is installed.

#### 3.1. Selecting an installation location

Decide the mounting position together with the customer as follows.

##### ⚠ WARNING

Select installation locations that can properly support the weight of the indoor unit. Install the units securely so that they do not topple or fall.

##### ⚠ CAUTION

Do not install the indoor unit in the following areas:

- Area with high salt content, such as at the seaside. It will deteriorate metal parts, causing the parts to fail or the unit to leak water.
- Area filled with mineral oil or containing a large amount of splashed oil or steam, such as a kitchen. It will deteriorate plastic parts, causing the parts to fail or the unit to leak water.
- Area that generates substances that adversely affect the equipment, such as sulfuric gas, chlorine gas, acid, or alkali. It will cause the copper pipes and brazed joints to corrode, which can cause refrigerant leakage.
- Area that can cause combustible gas to leak, contains suspended carbon fibers or flammable dust, or volatile inflammables such as paint thinner or gasoline. If gas leaks and settles around the unit, it can cause a fire.
- Area where animals may urinate on the unit or ammonia may be generated.

Do not use the unit for special purposes, such as storing food, raising animals, growing plants, or preserving precision devices or art objects. It can degrade the quality of the preserved or stored objects.

Do not install where there is the danger of combustible gas leakage.

Do not install the unit near a source of heat, steam, or flammable gas.

Install the unit where drainage does not cause any trouble.

Install the indoor unit, power supply cable, transmission cable, and remote controller cable at least 40 in (1 m) away from a television or radio receivers. The purpose of this is to prevent TV reception interference or radio noise. (Even if they are installed more than 40 in (1 m) apart, you could still receive noise under some signal conditions.)

If children under 10 years old may approach the unit, take preventive measures so that they cannot reach the unit.

Take precautions to prevent the unit from falling.

- (1) Install the indoor unit on a place having a sufficient strength so that it withstands against the weight of the indoor unit.
- (2) The inlet and outlet ports should not be obstructed; the air should be able to blow all over the room.
- (3) Leave the space required to service the air conditioner.
- (4) Install the unit where connection to the outdoor unit (or RB unit) is easy.
- (5) Install the unit where the connection pipe can be easily installed.
- (6) Install the unit where the drain pipe can be easily installed.
- (7) Install the unit where noise and vibrations are not amplified.
- (8) Take servicing, etc., into consideration and leave the spaces. Also install the unit where the filter can be removed.
- (9) Do not install the unit where it will be exposed to direct sunlight.

#### Detection range of the human sensor

##### ⚠ CAUTION

Do not hit or push the human sensor. This may lead to damage or malfunction.

Do not touch the human sensor. Any scratches or dirt may lead to incorrect detection.

Do not place large objects near the human sensor. Also keep heating units outside the sensor's detection area.

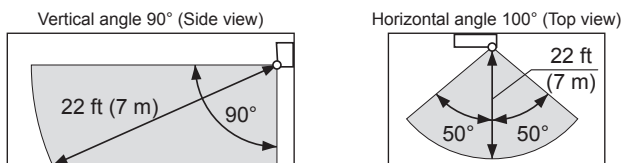

#### 3.2. Installation dimension

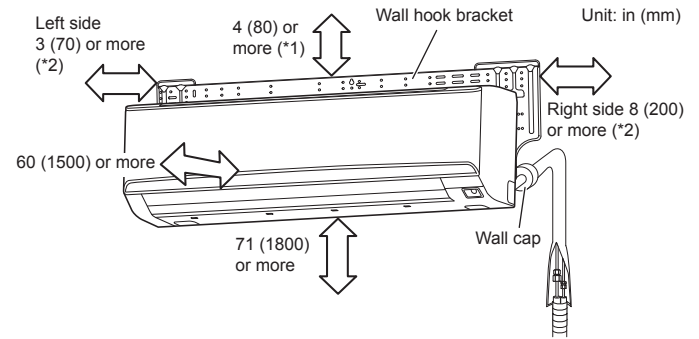

\*1: The distance between the wall hook bracket and the ceiling.

\*2: The distance between the wall hook bracket and the side wall.

#### 3.3. Installing the unit

##### ⚠ WARNING

Install the air conditioner in a location which can withstand a load of at least 5 times the weight of the main unit and which will not amplify sound or vibration. If the installation location is not strong enough, the indoor unit may fall and cause injuries.

If the job is done with the panel frame only, there is a risk that the unit will come loose. Please take care.

##### 3.3.1. Determining the piping direction

The piping can be connected according to the figure and table. When the piping is connected in direction (B), (C), (D) or (E), cut along the piping groove in the side of the front panel with a hacksaw.

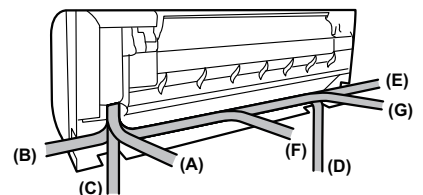

Model	(A) Rear outlet	(B) Right outlet	(C) Bottom outlet	(D) Left bottom outlet	(E) Left outlet	(F) Center outlet	(G) Left rear outlet
30/36	Good	Good	Good	Good	Good	Good	Good

##### 3.3.2. Installing the wall hook bracket

- Refer to figure below for the installation hole dimensions of the wall hook bracket.
  - Before fastening the wall hook bracket to the wall with the screws, level it by tapping the hook at the center of bracket to the wall with the handle of a screwdriver.
- (1) Fasten the wall hook bracket to the wall with 5 or more screws and anchor bolts through the holes near the outer edge of the bracket. (Do not install the wall hook bracket at only 1 place or at an angle.)
  - (2) For a concrete wall, embed anchor bolts (3/8 in (10 mm) dia.) into the wall at the wall hook bracket holes. (Allow the anchor bolts to stick out at least 11/16 in (18 mm) from the wall. Use 2 bolts for flat concrete wall and 4 bolts for blister concrete wall.)
  - (3) Install the nuts to the anchor bolts through the wall hook bracket.
  - (4) Finally tighten the bolts and wood screws after confirming, using the level indicator, that the clamp is horizontal.

##### ⚠ WARNING

Install the wall hook bracket level, both horizontally and vertically. If the wall hook bracket is tilted, water will drip to the floor.

As the weight of the indoor unit is 33 to 40 lbs (15 to 18 kg), it should be installed after properly examining the place where it is intended to be installed. If the place is not strong enough, a plank or girder should be used to make the place sufficiently strong so that the wall can support the weight.

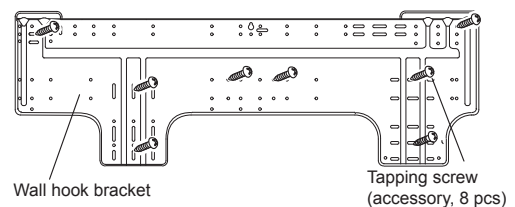

### 3.3.3. Cutting the hole in the wall for the connecting piping

- (1) Cut a hole in the wall at the position shown in the following.
- (2) Cut the hole so that the outside end is lower (3/16 to 3/8 in (5 to 10 mm)) than the inside end.
- (3) Always align the center of the wall hole. If misaligned, water leakage will occur.
- (4) Cut the wall pipe to match the wall thickness, stick it into the wall cap, fasten the cap with vinyl tape, and stick the pipe through the hole.
- (5) For left piping and right piping, cut the hole a little lower so that drain water will flow freely.

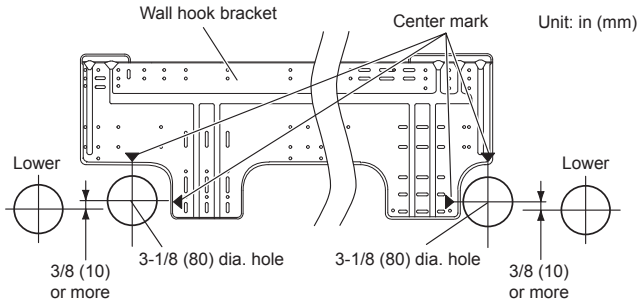

#### Attach the wall pipe

##### ⚠ WARNING

If the wall pipe is not used, the cable interconnecting the indoor and outdoor units may touch metal and cause electric leakage.

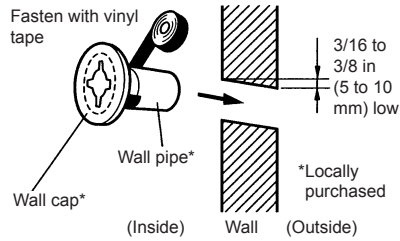

### 3.3.4. Attach the drain hose insulation (30/36 model only)

- Wrap the insulation around the drain hose, making sure that there are no gaps.
- Attach the Insulation (drain hose) to the drain hose.

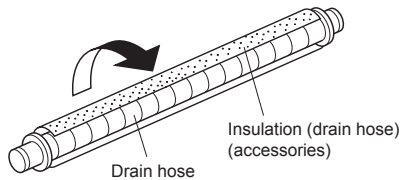

### 3.3.5. Forming the drain hose and pipe

##### ⚠ CAUTION

Insert drain hose and drain cap securely. Drain should slope down to avoid water leakage.

When inserting the drain hose, no other material than water should be applied. Application of other material than water will cause deterioration of the hose, and may cause water leakage.

After you remove a drain hose, be sure to attach the drain cap.

When you secure the piping and drain hose with tape, arrange the drain hose so that it is at the bottom of the piping.

For drain hose piping in low temperature environment, you need to apply freeze protection to prevent a frozen drain hose.

After cooling operation is performed in low temperature environment, (when outdoor temperature under 32°F (0°C),) water in the drain hose could be frozen. Frozen drain water will block the water flow in the hose, and may cause water leakage at the indoor unit.

#### [For (A) Rear piping, (B) Right piping and (C) Bottom piping]

- (1) Install the indoor unit piping in the direction of the wall hole and bind the drain hose and pipe together with vinyl tape.
- (2) Install the piping so that the drain hose is at the bottom.
- (3) Wrap the pipe of the indoor unit that visible from the outside with decorative tape.
- (4) For right or bottom outlet piping, cut off the piping outlet cutting groove with a hacksaw.

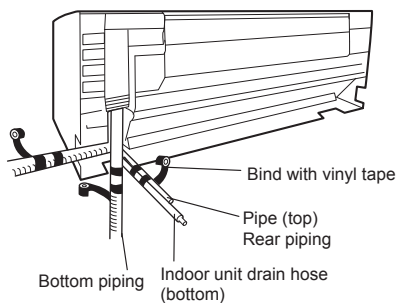

#### [For (D) Left bottom piping, (E) Left piping and (F) Center piping, (G) Left rear piping]

##### ⚠ CAUTION

Insert the drain hose and drain cap into the drain port, making sure that it comes in contact with the back of the drain port, and then mount it. If the drain hose is not connected properly, leaking will occur.

- (1) Interchange the drain cap and the drain hose.

- For left outlet piping, cut off the piping outlet cutting groove with a hacksaw.
- Remove the drain cap by pulling at the projection at the end of the cap with pliers, etc.

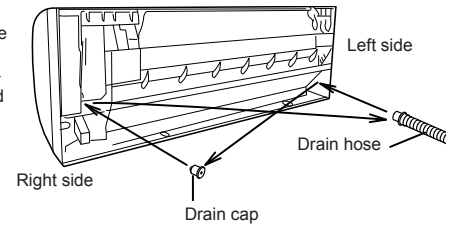

#### Installing the drain cap

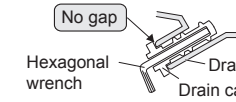

Use a hexagonal wrench 3/16 in (4 mm) at opposite side to insert the drain cap, till the drain cap contacts the tip of drain cock.

- (2) Align the marks on the wall hook bracket and shape the connection pipe. For left piping and left rear piping, align the marks on the wall hook bracket and shape the connection pipe.

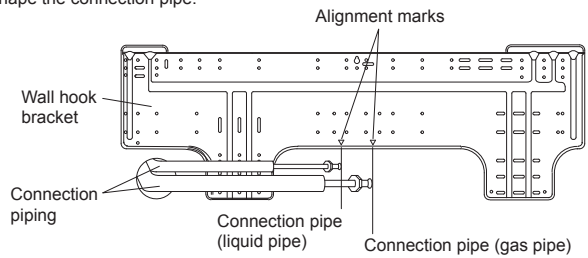

- (3) Bend the connection piping at the bend radius of 4 in (100 mm) or more and install no more than 2 in (35 mm) from the wall.

### 3.3.6. Installing the indoor unit

- (1) After passing the indoor piping and drain hose through the wall hole, hang the indoor unit on the hooks at the top and bottom of the wall hook bracket. After hooking the indoor unit to the top hook, hook the fittings of the indoor unit to the 2 bottom hooks while lowering the unit and pushing it against the wall.

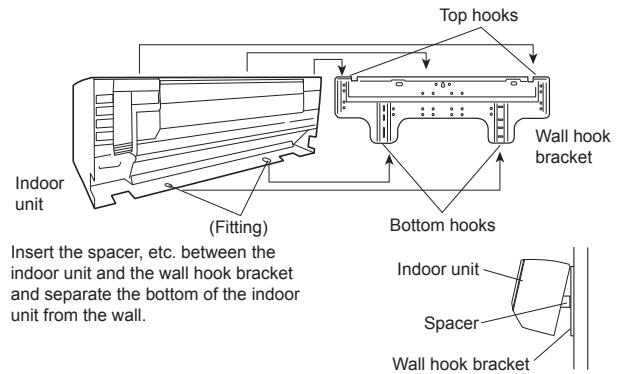

- (2) Insert the spacer, etc. between the indoor unit and the wall hook bracket and separate the bottom of the indoor unit from the wall.

## 4. PIPE INSTALLATION

### ⚠ CAUTION

Be more careful that foreign matter (oil, water, etc.) does not enter the piping than with refrigerant R410A models. Also, when storing the piping, securely seal the openings by pinching, taping, etc.

While welding the pipes, be sure to blow dry nitrogen gas through them.

### 4.1. Selecting the pipe material

### ⚠ CAUTION

Do not use existing pipes from another refrigeration system or refrigerant.

Use pipes that have clean external and internal sides without any contamination which may cause trouble during use, such as sulfur, oxide, dust, cutting waste, oil, or water.

It is necessary to use seamless copper pipes.  
Material: Phosphor deoxidized seamless copper pipes  
It is desirable that the amount of residual oil is less than 0.004 oz/100 ft (40 mg/10 m).

Do not use copper pipes that have a collapsed, deformed, or discolored portion (especially on the interior surface). Otherwise, the expansion valve or capillary tube may become blocked with contaminants.

Improper pipe selection will degrade performance. As an air conditioner using R410A incurs pressure higher than when using conventional (R22) refrigerant, it is necessary to choose adequate materials.

- Thicknesses of copper pipes used with R410A are as shown in the table.
- Never use copper pipes thinner than those indicated in the table even if they are available on the market.

#### Thicknesses of Annealed Copper Pipes (R410A)

Pipe outside diameter [in (mm)]	Thickness [in (mm)]
1/4 (6.35)	0.032 (0.80)
3/8 (9.52)	0.032 (0.80)
1/2 (12.70)	0.032 (0.80)
5/8 (15.88)	0.039 (1.00)
3/4 (19.05)	0.039 (1.20)

### 4.2. Pipe requirement

### ⚠ CAUTION

Refer to the installation manual for the outdoor unit for description of allowable pipe length and height difference.

Use pipe with water-resistant heat insulation.

### ⚠ CAUTION

Install heat insulation around both the gas and liquid pipes. Failure to do so may cause water leaks.

Use heat insulation with heat resistance above 248 °F (120 °C). (Reverse cycle model only)

In addition, if the humidity level at the installation location of the refrigerant piping is expected to exceed 70 %, install heat insulation around the refrigerant piping. If the expected humidity level is 70 to 80 %, use heat insulation that is 9/16 in (15 mm) or thicker and if the expected humidity exceeds 80 %, use heat insulation that is 13/16 in (20 mm) or thicker. If heat insulation is used that is not as thick as specified, condensation may form on the surface of the insulation. In addition, use heat insulation with heat conductivity of 0.045 W/(m·K) or less (at 68 °F (20 °C))

### 4.3. Flare connection (pipe connection)

### ⚠ WARNING

Tighten the flare nuts with a torque wrench using the specified tightening method. Otherwise, the flare nuts could break after a prolonged period, causing refrigerant to leak and generate hazardous gas if the refrigerant comes into contact with a flame.

#### 4.3.1. Flaring

Use special flare tool exclusive for R410A.

- (1) Cut the connection pipe to the necessary length with a pipe cutter.
- (2) Hold the pipe downward so that cuttings will not enter the pipe and remove any burrs.
- (3) Insert the flare nut (always use the flare nut attached to the indoor and outdoor units (or RB unit) respectively) onto the pipe and perform the flare processing with a flare tool. Use the special R410A flare tool. Leakage of refrigerant may result if other flare nuts are used.
- (4) Protect the pipes by pinching them or with tape to prevent dust, dirt, or water from entering the pipes.

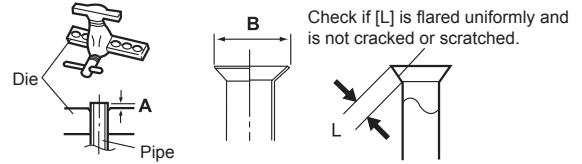

Pipe outside diameter [in (mm)]	Dimension A [in (mm)]	Dimension B $\begin{matrix} 0 \\ -0.015 \end{matrix}$ (-0.4) [in (mm)]
	Flare tool for R410A, clutch type	
1/4 (6.35)	0 to 0.020 (0 to 0.5)	3/8 (9.1)
3/8 (9.52)		1/2 (13.2)
1/2 (12.70)		5/8 (16.6)
5/8 (15.88)		3/4 (19.7)
3/4 (19.05)		15/16 (24.0)

When using conventional (R22) flare tools to flare R410A pipes, the dimension A should be approximately 0.02 in (0.5 mm) more than indicated in the table (for flaring with R410A flare tools) to achieve the specified flaring. Use a thickness gauge to measure the dimension A. It is recommended that a R410A flaring tool is used.

Width across flats	Pipe outside diameter [in (mm)]	Width across flats of Flare nut [in (mm)]
		1/4 (6.35)
	3/8 (9.52)	7/8 (22)
	1/2 (12.70)	1 (26)
	5/8 (15.88)	1-1/8 (29)
	3/4 (19.05)	1-7/16 (36)

#### 4.3.2. Bending pipes

- The pipes are shaped by your hands or pipe bender. Be careful not to collapse them.
- Do not bend the pipes in an angle more than 90°.
- When pipes are repeatedly bent or stretched, the material will harden, making it difficult to bend or stretch them anymore. Do not bend or stretch the pipes more than 3 times.

### ⚠ CAUTION

To prevent breaking of the pipe, avoid sharp bends.

If the pipe is bent repeatedly at the same place, it will break.

#### 4.3.3. Pipe connection

When the flare nut is tightened properly by your hand, hold the body side coupling with a separate spanner, then tighten with a torque wrench.

### ⚠ CAUTION

Be sure to install the pipe against the port on the indoor unit and the outdoor unit correctly. If the centering is improper, the flare nut cannot tighten smoothly. If the flare nut is forced to turn, the threads will be damaged.

Do not remove the flare nut from the indoor unit pipe until immediately before connecting the connection pipe.

Do not use mineral oil on flared part. Prevent mineral oil from getting into the system as this would reduce the lifetime of the units.

Hold the torque wrench at its grip, keeping it at a right angle with the pipe, in order to tighten the flare nut correctly.

Flare nut [in (mm)]	Tightening torque [lbf-ft (N·m)]
1/4 (6.35) dia.	11.8 to 13.3 (16 to 18)
3/8 (9.52) dia.	23.6 to 31.0 (32 to 42)
1/2 (12.70) dia.	36.1 to 45.0 (49 to 61)
5/8 (15.88) dia.	46.5 to 55.3 (63 to 75)
3/4 (19.05) dia.	66.4 to 81.1 (90 to 110)

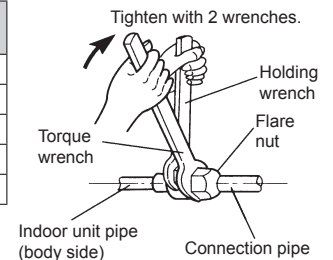

## 5. ELECTRICAL WIRING

### ⚠ WARNING

Electrical work must be performed in accordance with this Manual by a person certified under the national or regional regulations. Be sure to use a dedicated circuit for the unit. An insufficient power supply circuit or improperly performed electrical work can cause serious accidents such as electric shock or fire.

Before starting work, check that power is not being supplied to the all units.

Use the included connection cables and power cables or ones specified by the manufacturer. Improper connections, insufficient insulation, or exceeding the allowable current can cause electric shock or fire.

For wiring, use the prescribed type of cables, connect them securely, making sure that there are no external forces of the cables applied to the terminal connections. Improperly connected or secured cables can cause serious accidents such as overheating the terminals, electric shock, or fire.

Do not modify the power cables, use extension cables, or use any branches in the wiring. Improper connections, insufficient insulation, or exceeding the allowable current can cause electric shock or fire.

Match the terminal board numbers and connection cable colors with those of the outdoor unit (or RB unit). Erroneous wiring may cause burning of the electric parts.

Securely connect the connection cables to the terminal board. In addition, secure the cables with wiring holders. Improper connections, either in the wiring or at the ends of the wiring, can cause a malfunction, electric shock, or fire.

Always fasten the outside covering of the connection cable with the cable clamp. (If the insulator is chafed, electric discharge may occur.)

Securely install the electrical box cover on the unit. An improperly installed electrical box cover can cause serious accidents such as electric shock or fire through exposure to dust or water.

Install sleeves into any holes made in the walls for wiring. Otherwise, a short circuit could result.

We suggest installing GFEB breakers or follow local electrical code. When installing this system, install using ground fault equipment breakers (GFEB) to reduce the risk of leaking current which result in electric shock or potential fire.

Always connect the earth (ground) cable. Improper earthing (grounding) work can cause electric shocks.

Install the remote controller cables so as not to be direct touched with your hand.

Perform wiring work in accordance with standards so that the air conditioner can be operated safely and positively.

Connect the connection cable firmly to the terminal board. Imperfect installation may cause a fire.

If the supply cable is damaged, it must be replaced by the manufacturer, its service agent or similarly qualified persons in order to avoid a hazard.

### ⚠ CAUTION

Earth (Ground) the unit. Do not connect the earth (ground) cable to a gas pipe, water pipe, lightning rod, or a telephone earth (ground) cable. Improper earthing (grounding) may cause electric shock.

Do not connect power supply cable to the transmission or remote controller terminals, as this will damage the product.

Never bundle the power supply cable and transmission cable, remote controller cable together. Separate these cables by 2 in (50 mm) or more. Bundling these cables together will cause miss operation or breakdown.

When handling PCB, static electricity charged in the body may cause malfunction of the PCB. Follow the cautions below:

- Establish an earth (ground) for the indoor and outdoor units and peripheral devices.
- Cut power (breaker) off.
- Touch metal part of the indoor units for more than 10 seconds to discharge static electricity charged in the body.
- Do not touch terminals of parts and patterns implemented on PCB.

## 5.1. Electrical requirement

- Select the power cable type and size in accordance with relevant local and national regulations.

<b>Voltage rating</b>	208/230 V
<b>Operating range</b>	187 to 253 V

- Specifications for local wiring power cord and branch wiring are in compliance with local code.
- Max. wire length: Set a length so that the voltage drop is less than 2%. Increase the wire diameter when the wire length is long.

Breaker should be installed at every refrigerant system. Do not use a breaker in a different refrigerant system.

Refer to the table for the breaker specifications of each installation condition. Perform the power crossover wiring within the range of the same refrigerant system. When the crossover wiring is done, make a connection for indoor units to satisfy conditions A and B below.

## A. Current breaker requirements

Model	MCA	MAX. CKT. BKR (Fuse capacity)
ASUA30TLAV2	0.90 A	15 A
ASUA36TLAV2	1.18 A	

- MCA: Minimum Circuit Ampacity
- MAX. CKT. BKR : Maximum Circuit Breaker

When the power crossover wiring is done, make it so that the total of the MCA of the connected RB units and indoor units does not exceed the 11 A. For RB unit MCA, refer to the RB unit installation manual.

If the capacity of connected RB units and indoor units exceeds the upper limit, either add breakers or use a breaker with a greater capacity.

## B. Earth leakage breaker requirements

Breaker capacity	Maximum connectable "indoor units" or "indoor units + RB units" (*1)
30 mA, 0.1 sec or less	36 or less
100 mA, 0.1 sec or less	37 to 121 (*2)

- \*1: Heat pump type: indoor units, Heat recovery type: indoor units and RB units.
- \*2: If the 100 mA capacity breaker is not provided, split the quantity of the indoor units into small groups of 36 units or less and provide a breaker with capacity of 30 mA for each group.

## 5.1.1. Cable specifications

Use	Cable size (AWG)	Cable type	Remarks
Transmission cable	22	LEVEL 4 (NEMA) non-polar 2 core, twisted pair solid core diameter 0.026 in (0.65 mm)	LONWORKS® compatible cable
Remote controller cable (2-wire type)	22 to 16	Sheathed PVC cable	Non polar 2 core, twisted pair
	18	Thermostat cable 2 core	Use sheathed non twisted pair cable

## 5.2. Wiring method

### Example

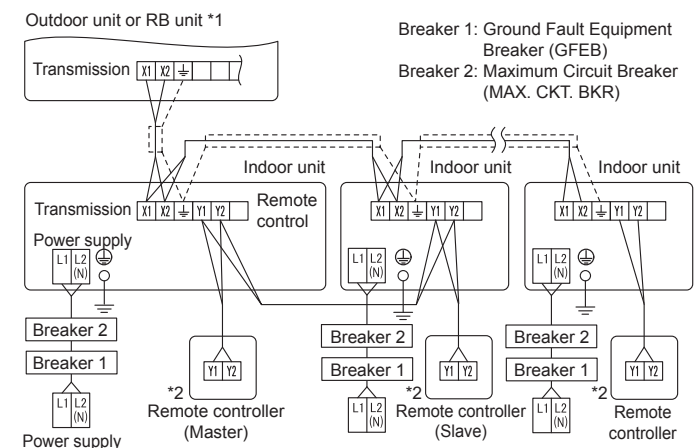

\*1: When connecting to the Heat Recovery System, refer to the installation manual of the RB unit.

\*2: The 3-wire type remote controller is not used.

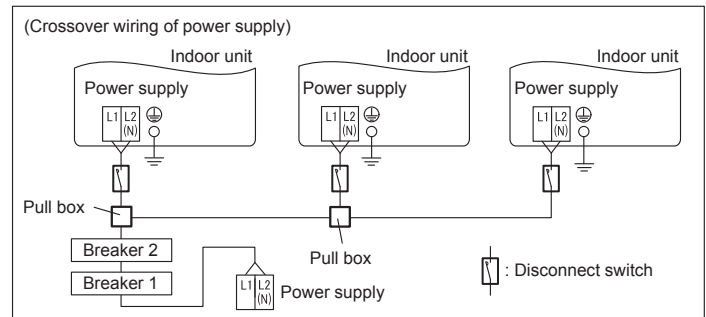

Disconnect switch shall be installed between indoor unit and pull box.

### 5.3. Unit wiring

• Before attaching the cable to terminal block.

#### 5.3.1. Power supply cable

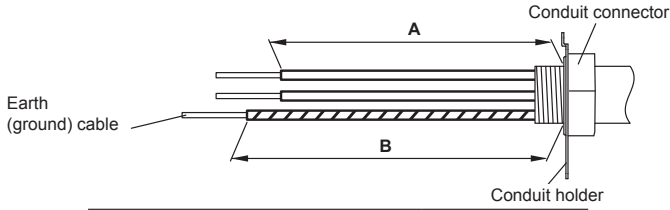

	A [in (mm)]	B [in (mm)]
30/36 model	9-7/16 (240)	10-1/4 (260)

#### A. For solid core wiring

- (1) To connect the electrical terminal, follow the below diagram and connect after looping it around the end of the cable.
- (2) Use the specified cables, connect them securely, and fasten them so that there is no stress placed on the terminals.
- (3) Use an appropriate screwdriver to tighten the terminal screws. Do not use a screwdriver that is too small, otherwise, the screw heads may be damaged and prevent the screws from being properly tightened.
- (4) Do not tighten the terminal screws too much, otherwise, the screws may break.
- (5) See the table for the terminal screw tightening torques.
- (6) Please do not fix 2 power supply cables with 1 screw.

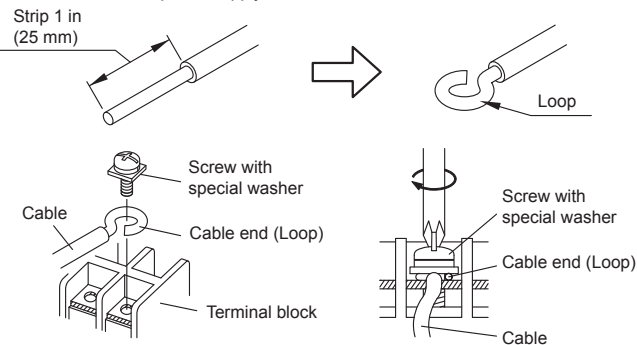

**WARNING**

When using solid core cables, do not use the attached ring terminal. If you use the solid core cables with the ring terminal, the ring terminal's pressure bonding may malfunction and cause the cables to abnormally heat up.

#### B. For strand wiring

- (1) Use ring terminals with insulating sleeves as shown in the figure below to connect to the terminal block.
- (2) Securely clamp the ring terminals to the cables using an appropriate tool so that the cables do not come loose.
- (3) Use the specified cables, connect them securely, and fasten them so that there is no stress placed on the terminals.
- (4) Use an appropriate screwdriver to tighten the terminal screws. Do not use a screwdriver that is too small, otherwise, the screw heads may be damaged and prevent the screws from being properly tightened.
- (5) Do not tighten the terminal screws too much, otherwise, the screws may break.
- (6) See the table for the terminal screw tightening torques.
- (7) Please do not fix 2 power supply cables with 1 screw.

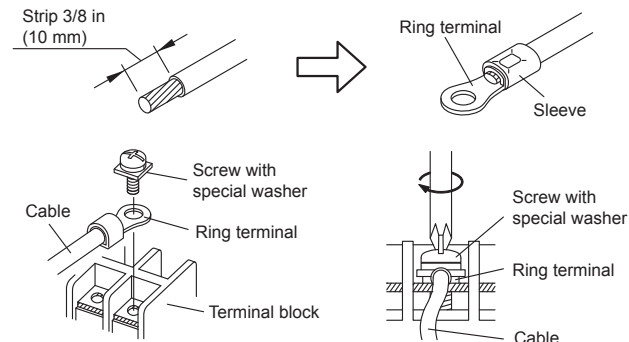

**WARNING**

Use ring terminals and tighten the terminal screws to the specified torques, otherwise, abnormal overheating may be produced and possibly cause heavy damage inside the unit.

Terminal number	Tightening torque
M4 screw (Power supply/L1, L2(N), GND)	11 to 16 lbf-in (1.2 to 1.8 N·m)

#### 5.3.2. Transmission and Remote controller cable

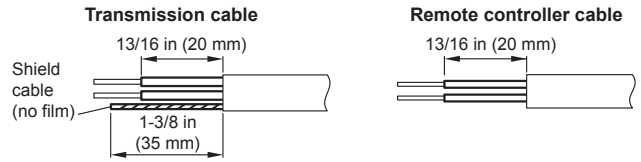

• Connect remote controller and transmission cables as shown in figure below.

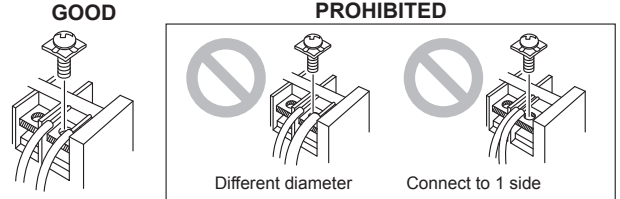

**WARNING**

Tighten the terminal screws to the specified torques, otherwise, abnormal overheating may be occurred and possibly cause serious damage inside the unit.

Terminal number	Tightening torque
M3 screw (Transmission /X1, X2) (Remote controller /Y1, Y2)	4.4 to 5.3 lbf-in (0.5 to 0.6 N·m)

**CAUTION**

To peel the sheath from the lead cable, use a dedicated tool that will not damage the conductor cable.

When installing a screw on the terminal block, do not cut the wire by overtightening the screw. On the other hand, an under tightened screw can cause faulty contact, which will lead to a communication failure.

### 5.4. Wiring

- (1) Open the intake grille. Refer to "8. FRONT PANEL REMOVAL AND INSTALLATION".
- (2) Remove the wire cover and remove the cable clamp.

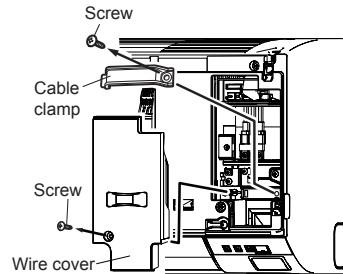

- (3) Remove the conduit holder.
- (4) Fasten the indoor unit wire harness to the conduit holder using the lock nut.
- (5) Use the screws to install the conduit holder provide with the indoor unit.

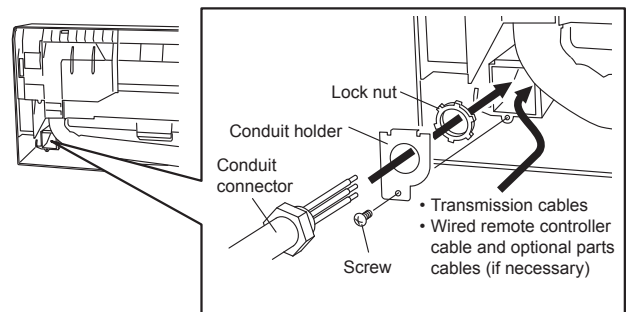

(6) Connect the end of the connection cable fully into the terminal block.

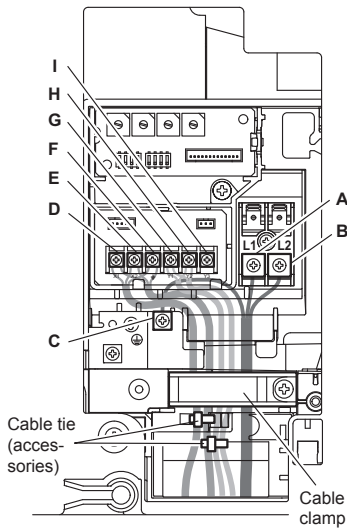

Symbol	Connection cable
A	L1 Power supply cable
B	L2
C	Earth (ground) for power supply cable
D	X1 Transmission cable
E	X2
F	Earth (ground) for transmission cable and wired remote controller cable (if necessary)
G	Y1 Wired remote controller cable (nonpolar)
H	Y2
I	Y3 Do not use

(7) Fix the conduit with the supporters as shown below.

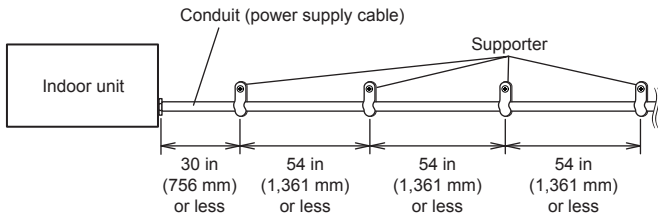

## 5.5. Optional parts wiring

In this setting, you need to remove the front panel. Refer to "8. FRONT PANEL REMOVAL AND INSTALLATION".

### 5.5.1. Connector and DIP switch position

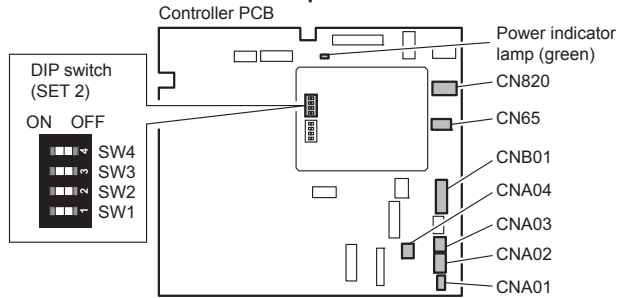

Name	Application
CNA01	Apply voltage terminal
CNA03	Dry contact terminal
CNA02	
CNA04	
DIP switch SET 2 (SW2)	Input signal type switching
CNB01	Output terminal
CN65	For one of the following. • MODBUS® convertor (*1) • Wireless LAN adapter (*1)
CN820	For External power supply unit (*1)

\*1: For details, refer to each installation manual.

### 5.5.2. Power indicator lamp status

Power indicator lamp (Green)	Status contents
○ Lit	Lit when the power is turned on.
● Fast flashing (every 0.1 second)	There is a fault with the communication board or the main board.
● Blinking (repeat 3 seconds ON and 1 second OFF)	The indoor unit is turned off and power is supplied from the External power supply unit (optional) to the indoor unit PCB.

## 5.5.3. Connection methods

### Wire modification

- Remove insulation from wire attached to wire kit connector.
- Remove insulation from field supplied cable. Use crimp type insulated butt connector to join field cable and wire kit wire.
- Connect the wire with connecting wire with solder.

**IMPORTANT:**  
Be sure to insulate the connection between the wires.

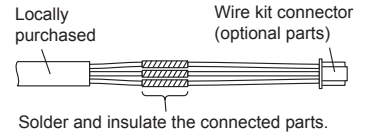

### Wiring arrangement

In following figure, all the possible connectors are connected for description. In actual installation, you cannot connect all the connectors at once.

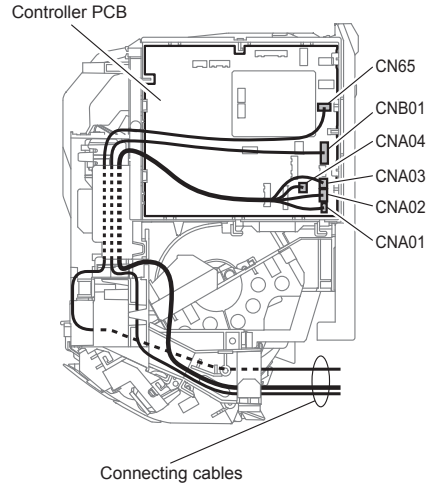

When replacing the control box cover, be sure to attach the wire with the screw.

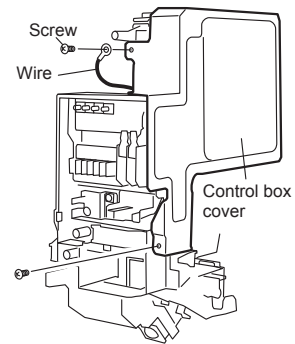

## 5.6. External input and external output (optional parts)

In this setting, you need to remove the front panel. Refer to "8. FRONT PANEL REMOVAL AND INSTALLATION".

### 5.6.1. External input

- Indoor unit can be Operation/Stop, Emergency stop or Forced stop by using indoor unit PCB CNA01 or CNA02.
- "Operation/Stop" mode, "Emergency stop" mode or "Forced stop" mode can be selected with function setting of indoor unit.
- Indoor unit can be Forced thermostat off by using indoor unit PCB CNA03 or CNA04.
- A twisted pair cable (22 AWG) should be used. Maximum length of cable is 192 ft (150 m).
- Use an external input and output cable with appropriate external dimension, depending on the number of cables to be installed.
- The wire connection should be separate from the power cable line.

#### Input select

Use either one of these types of terminal according to the application. (Both types of terminals cannot be used simultaneously.)

#### • Apply voltage terminal ([CNA01], [CNA03])

When a power supply must be provided at the input device you want to connect, use the Apply voltage terminal ([CNA01], [CNA03]).

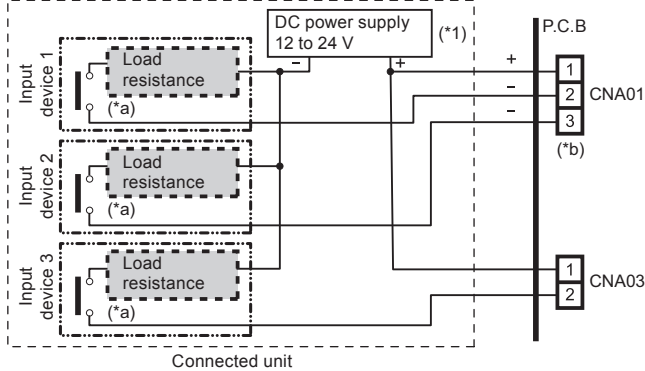

\*1: Make the power supply DC 12 to 24 V. Select a power supply capacity with an ample surplus for the connected load.  
Do not impress a voltage exceeding 24 V across pins 1-2, and 1-3.

\*a: The allowable current is DC 5 mA to 10 mA. (Recommended: DC 5 mA)  
Provide a load resistance such that the current becomes DC 10 mA or less.  
Select very low current use contacts (usable at DC 12 V, DC 1 mA or less).

\*b: The polarity is [+] for pin 1 and [-] for pin 2 and 3. Connect correctly.

When connected to Apply voltage terminals of multiple indoor units with a connected unit, be sure to make a branch outside the indoor unit using a pull box, etc. as shown on below example.

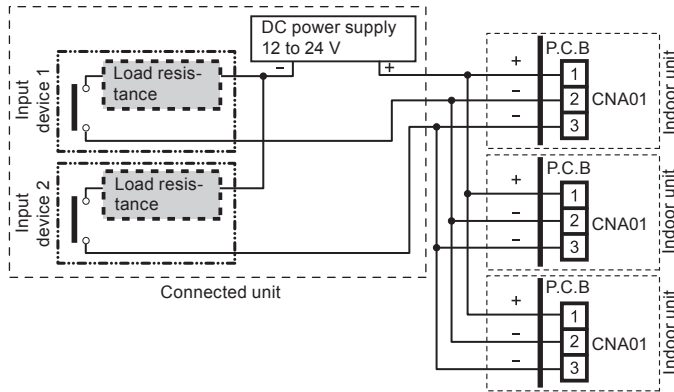

#### • Dry contact terminal ([CNA02], [CNA04])

When a power supply is unnecessary at the input device you want to connect, use the Dry contact terminal ([CNA02], [CNA04]).

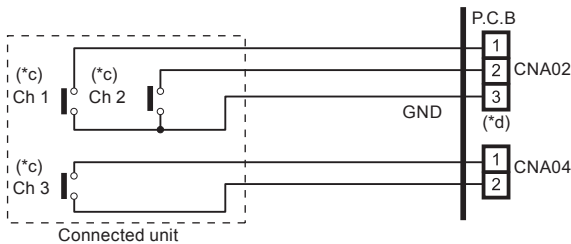

\*c: Select very low current use contacts (usable at DC 12 V, DC 1 mA or less).

\*d: The wiring is different from Apply voltage terminals. Be sufficiently careful when wiring.

When connected to Dry contact terminals of multiple indoor units with a connected unit, insulate each indoor unit with relay, etc. as shown on below example.

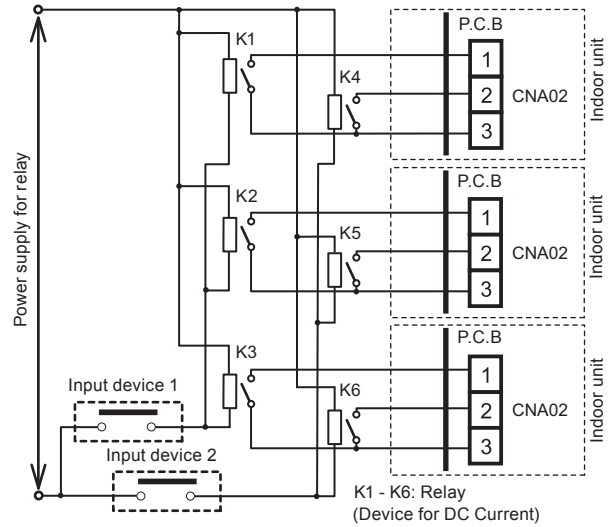

#### NOTE:

When connected to multiple indoor units directly, it will cause breakdown.

#### Operation behavior

##### • Input signal type

The input signal type can be selected.  
It is switched by DIP switch on the indoor unit PCB.

DIP switch [SET2 SW2]	Input signal type
OFF (Factory setting)	Edge
ON	Pulse

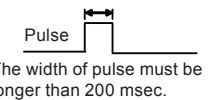
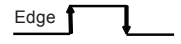

##### • When function setting is "Operation/Stop" mode.

Input	Connector	Input signal	Command	
Edge	Ch1 of CNA01 or CNA02	OFF → ON	Operation	
		ON → OFF	Stop	
Pulse	CNA01 or CNA02	Ch1	OFF → ON	Operation
	Ch2	OFF → ON	Stop	

\* The last command has priority.

\* The indoor units within the same remote controller group operates in the same mode.

##### • When function setting is "Emergency stop" mode.

Input	Connector	Input signal	Command	
Edge	Ch1 of CNA01 or CNA02	OFF → ON	Emergency stop	
		ON → OFF	Normal	
Pulse	CNA01 or CNA02	Ch1	OFF → ON	Emergency stop
	Ch2	OFF → ON	Normal	

\* All indoor units of same refrigerant system stops when Emergency stop operates.

##### • When function setting is "Forced stop" mode.

Input	Connector	Input signal	Command	
Edge	Ch1 of CNA01 or CNA02	OFF → ON	Forced stop	
		ON → OFF	Normal	
Pulse	CNA01 or CNA02	Ch1	OFF → ON	Forced stop
	Ch2	OFF → ON	Normal	

\* When the forced stop is triggered, indoor unit stops and Operation/Stop operation by a remote controller is restricted.

\* When forced stop function is used with forming a remote controller group, connect the same equipment to each indoor unit within the group.

#### • Selection method of functions

"Operation/Stop" mode or "Emergency stop" mode, "Forced stop" mode can be selected with function setting of indoor unit.

#### • Forced thermostat off function ("Edge" input only)

\*If function setting "60" is set to "00"

### 5.6.2. External output

- A twisted pair cable (22AWG) should be used. Maximum length of cable is 282 ft (5 m).
- Use an external input and output cable with appropriate external dimension, depending on the number of cables to be installed.
- Output voltage: Hi DC 12 V  $\pm$  2 V, Lo 0 V.
- Permissible current: 50 A

## Output select

### • When indicator etc. are connected directly

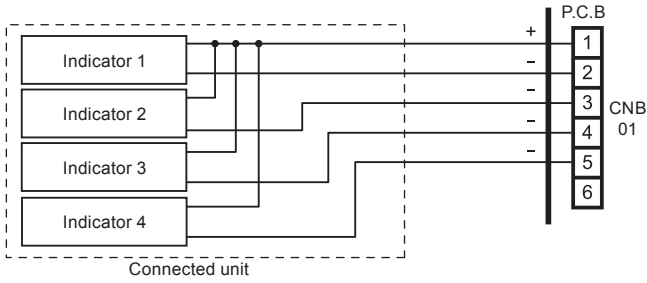

### • When connecting with unit equipped with a power supply

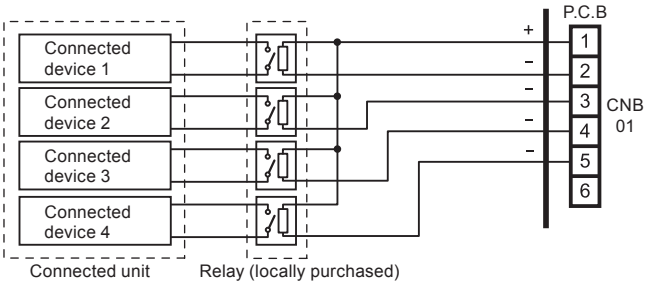

## Operation behavior

\* If function setting "60" is set to "00"

Connector	Output voltage	Status	
CNB01	External output 1 Pins 1-2	0 V DC 12 V	Stop Operation
	External output 2 Pins 1-3	0 V DC 12 V	Normal Error
	External output 3 Pins 1-4	0 V	Indoor unit fan stop
		DC 12 V	Indoor unit fan operation
External output 4 Pins 1-5	0 V	External heater OFF	
	DC 12 V	External heater ON	

### • Indoor unit fan setting for external heater

Fan setting when turning ON output to the connected external heater can be set by changing Dip switch on PC board.

Dip switch [SET2 SW3]	Fan setting when ON is output to the external heater	Explanation
OFF (Factory setting)	OFF	For the fan setting details, see the Design & Technical Manual.
ON	ON	

## 6. FIELD SETTING

There are 3 methods for address setting by FIELD SETTING as follows. Please set by either of the methods.

Each setting method is described in below (1) to (3).

- IU AD, REF AD SW settings: This section (6.1. Setting the address)
- Remote controller settings: Refer to the wired or wireless remote controller manual for detailed setting information. (Set IU AD, REF AD SW to 0)
- Automatic address settings: Refer to the outdoor unit manual for detailed setting information. (Set IU AD, REF AD SW to 0)

## 6.1. Setting the address

### Manual address setting method

The indoor unit address and the refrigerant circuit address can also be set up through the wireless remote controller

#### CAUTION

Be sure to turn OFF the power before performing the field setting.

- Position and detail of the switches

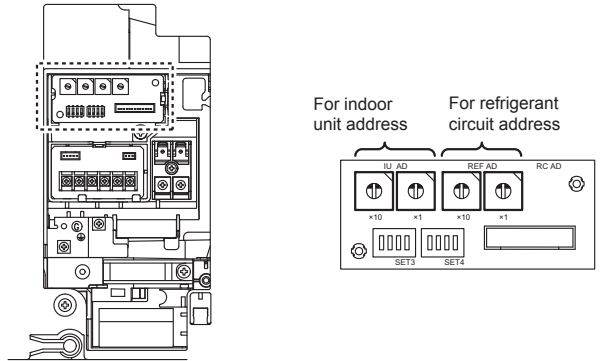

- Please set it according to the following procedures when setting manually.

#### CAUTION

Use an insulated screwdriver to set the dip switches.

Be careful not to make mistakes for switch settings.

Setting	Setting range	Type of switch
<b>Indoor unit address</b> <ul style="list-style-type: none"> <li>Rotary switch [IU AD × 1] (Factory setting "0")</li> <li>Rotary switch [IU AD × 10] (Factory setting "0")</li> </ul> <p>When connecting multiple indoor units to 1 refrigerant system, set the address at IU AD SW as shown in the Table A.</p>	0 to 63	<p>Setting example "2"</p> <p>IU AD × 10    IU AD × 1</p>
<b>Refrigerant circuit address</b> <ul style="list-style-type: none"> <li>Rotary switch [REF AD × 1] (Factory setting "0")</li> <li>Rotary switch [REF AD × 10] (Factory setting "0")</li> </ul> <p>In the case of multiple refrigerant systems, set REF AD SW as shown in the Table A for each refrigerant system. Set to the same refrigerant circuit address as the outdoor unit.</p>	0 to 99	<p>Setting example "63"</p> <p>REF AD × 10    REF AD × 1</p>

- If working in an environment where the wireless remote controller can be used, the addresses can also be set using the remote controller.
- If setting the addresses using the wireless remote controller, set the indoor unit address and refrigerant circuit address to "00". (For information on setting using the wireless remote controller.)

\* Do not set the indoor unit address (IU AD SW) at 64 to 99. It may result in failure.

Table A

Refrigerant circuit	Rotary switch setting		Address	Rotary switch setting	
	REF AD SW × 10	REF AD SW × 1		Indoor unit × 10	Indoor unit × 1
0	0	0	0	0	0
1	0	1	1	0	1
2	0	2	2	0	2
3	0	3	3	0	3
4	0	4	4	0	4
5	0	5	5	0	5
⋮	⋮	⋮	⋮	⋮	⋮
10	1	0	10	1	0
11	1	1	11	1	1
⋮	⋮	⋮	⋮	⋮	⋮
99	9	9	63	6	3

## 6.2. Custom code setting

- Selecting the custom code prevents the indoor unit mix-up. (figure below)  
(Up to 4 codes can be set.)
- Perform the setting for both the indoor unit and the remote controller.

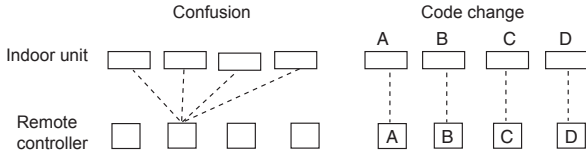

### • Custom code setting for indoor unit

Set the DIP switch SET3 SW1, 2, referring to the figure and table below.

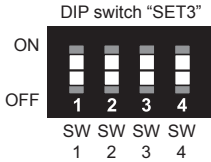
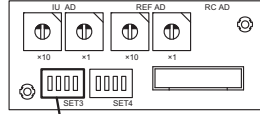

DIP switch SET3	Custom code			
	A (Factory setting)	B	C	D
SW1	OFF	ON	OFF	ON
SW2	OFF	OFF	ON	ON

## 6.3. Function setting

### ⚠ WARNING

Please make this setting after completing all construction works.

- FUNCTION SETTING can be performed with the wired or wireless remote controller. (The remote controller is optional equipment)
- Refer to the wired or wireless remote controller manual for detailed setting information.
- Refer to "6.1. Setting the address" for indoor unit address and refrigerant circuit address settings.
- Turn the power of the indoor unit ON before starting the setting.

\* Turning on the power to the indoor units initializes EEV, so make sure the piping air tight test and vacuuming have been conducted before turning on the power.

\* Also check again to make sure no wiring mistakes were made before turning on the power.

### Function details

Function	Function number	Setting number	Default	Details
Filter indicator interval	11	00 Standard	○	Adjust the filter cleaning interval notification. If the notification is too early, change to setting 01. If the notification is too late, change to setting 02.
		01 Longer		
		02 Shorter		
Filter indicator action	13	00 Enable	○	Enable or disable the filter indicator. Setting 02 is for use with a central remote controller.
		01 Disable		
		02 Display only on central remote controller		
(Forbidden)	20	00	○	
(Forbidden)	23	00	○	
Horizontal swing airflow direction	24	00 Standard	○	Adjust the horizontal swing airflow direction. (For horizontal swing equipped models)
		01 Left half		
		02 Right half		
(Forbidden)	26	31	○	
Cool air temperature trigger	30	00 Standard	○	Adjust the cool air trigger temperature. To lower the trigger temperature, use setting 01. To raise the trigger temperature, use setting 02.
		01 Adjust (1)		
		02 Adjust (2)		
Heat air temperature trigger	31	00 Standard	○	Adjust the heat air trigger temperature. To lower the trigger temperature by 6 degrees C, use setting 01. To lower the trigger temperature by 4 degrees C, use setting 02. To raise the trigger temperature, use setting 03.
		01 Adjust (1)		
		02 Adjust (2)		
		03 Adjust (3)		
Auto restart (*1)	40	00 Enable		Enable or disable automatic system restart after a power outage.
		01 Disable	○	
Cool Air Prevention	43	00 Super low	○	Restrain the cold airflow with making the airflow lower when starting heating operation. To correspond to the ventilation, set to 01.
		01 Follow the setting on the remote controller		

External control	46	00 Start/Stop	○	Allow an external controller to start or stop the system, or to perform an emergency stop. If an emergency stop is performed from an external controller, all refrigerant systems will be disabled. If forced stop is set, indoor unit stops by the input to the external input terminals, and Start/Stop by a remote controller is restricted.
		01 Emergency stop		
		02 Forced Stop		
Error report target	47	00 All	○	Change the target for reporting errors. Errors can either be reported in all locations, or only on the central remote controller.
		01 Display only on central remote controller		
Fan setting when cooling thermostat OFF	49	00 Follow the setting on the remote controller	○	When set to 01, the fan stops when the thermostat is OFF in cooling operation. Connection of the wired remote controller (2-wire type) and switching its thermistor are necessary.
		01 Stop		
Switching functions for external inputs and external outputs terminals (*2)	60	00 Mode 0	○	<ul style="list-style-type: none"> <li>• Set this function when connecting the VRF system to a ventilator, economizer, humidifier, or other external device.</li> <li>• The connection terminal functions can be changed depending on the type of external device. For details of the connection terminal functions, see the Design &amp; Technical Manual.</li> </ul>
		01 Mode 1		
		02 Mode 2		
		03 Mode 3		
		04 Mode 4		
		05 Mode 5		
		06 Mode 6		
		07 Mode 7		
		08 Mode 8		
Control switching of external heaters	61	00 Auxiliary heater control 1	○	Sets the control method for the external heater being used. For details of the control method, see the Design & Technical Manual.
		01 Auxiliary heater control 2		
		02 Heat pump prohibition control		
		03 Heater selection control using outdoor temperature 1		
		04 Heater selection control using outdoor temperature 2		
		05 Auxiliary heater control by outdoor temperature 3		
		06 Auxiliary heat pump control		
		07 Auxiliary heat pump control by outdoor temperature 1		
		08 Auxiliary heat pump control by outdoor temperature 2		
		09 Auxiliary heat pump control by outdoor temperature 3		
Operating temperature switching of external heaters	62	00 Setting 0	○	<ul style="list-style-type: none"> <li>• Sets the temperature conditions when the external heater is ON.</li> <li>• For the temperature conditions, see "Temperature conditions when the external heater is ON". For a more detailed explanation, see the Design &amp; Technical Manual.</li> </ul>
		01 Setting 1		
		02 Setting 2		
		03 Setting 3		
		04 Setting 4		
		05 Setting 5		
		06 Setting 6		
		07 Setting 7		
		08 Setting 8		
		09 Setting 9		
		10 Setting 10		
		11 Setting 11		
		12 Setting 12		
		13 Setting 13		
		14 Setting 14		
		15 Setting 15		
		16 Setting 16		
		17 Setting 17		
Auto mode type (*3)	68	00 Single setpoint auto mode (traditional)	○	Switch the setting method of auto mode to single or dual (cooling/heating). For heat pump systems, it is necessary to set the master indoor unit (by wired remote controller).
		01 Dual setpoint auto mode		

Function	Function number	Setting number	Default	Details	
Deadband value (*3)	69	00	0°F (0°C)	○	Choose the minimum temperature between cooling and heating settings (deadband) for Dual setpoint auto mode (set in No. 68).
		01	1°F (0.5°C)		
		02	2°F (1.0°C)		
		03	3°F (1.5°C)		
		04	4°F (2.0°C)		
		05	5°F (2.5°C)		
		06	6°F (3.0°C)		
		07	7°F (3.5°C)		
		08	8°F (4.0°C)		
(Forbidden)	70	00		○	
Standby time for auxiliary equipment operation	71	00	Disable	○	Sets the standby time until the auxiliary equipment operation starts during primary equipment operation.
		01	1 minutes		
		02	2 minutes		
		⋮	⋮		
		99	99 minutes		
Emergency heat	73	00	Disable	○	Enables or disable of emergency heat input.
		01	Enable		
Fan delay time	74	00	1 minutes	○	Sets the fan delay time when the heater is turned off.
		01	50 seconds		
		02	40 seconds		
		03	30 seconds		
External heater use in defrosting. (*4)	75	00	Disable	○	Enables or disables the external heater use in defrosting.
		01	Enable		

- \*1: Auto restart is an emergency function such as for power failure etc. Do not start and stop the indoor unit by this function in normal operation. Be sure to operate by the control unit, converter or external input device.
- \*2: Inappropriate setting may cause an external device malfunction. Confirm whether all the settings have been performed appropriately according to the installing condition.
- \*3: Function number 68 and 69 will be usable provided that the corresponding operating device is connected.
- \*4: When using function number 75, inappropriate heater selection may cause cold air in defrosting.

#### Temperature conditions when the external heater is ON/OFF

Temperature (t) = Room temperature - set temperature

		Set value of function: 61			
		00		01 to 09	
		ON	OFF	ON	OFF
Set value of function: 62	00	t < -5.4°F (-3°C)	t ≥ -1.8°F (-1°C)	t ≤ -0.9°F (-0.5°C)	t ≥ +0.9°F (+0.5°C)
	01	t < -3.6°F (-2°C)	t ≥ -1.8°F (-1°C)	t ≤ -1.8°F (-1°C)	t ≥ +0.9°F (+0.5°C)
	02	t < -3.6°F (-2°C)	t ≥ -1.8°F (-1°C)	t ≤ -3.6°F (-2°C)	t ≥ +0.9°F (+0.5°C)
	03	t < -5.4°F (-3°C)	t ≥ -1.8°F (-1°C)	t ≤ -5.4°F (-3°C)	t ≥ +0.9°F (+0.5°C)
	04	t < -7.2°F (-4°C)	t ≥ -1.8°F (-1°C)	t ≤ -7.2°F (-4°C)	t ≥ +0.9°F (+0.5°C)
	05	t < -9.0°F (-5°C)	t ≥ -1.8°F (-1°C)	t ≤ -9.0°F (-5°C)	t ≥ +0.9°F (+0.5°C)
	06	t < -5.4°F (-3°C)	t ≥ -0.9°F (-0.5°C)	t ≤ -0.9°F (-0.5°C)	t ≥ 0°F (0°C)
	07	t < -3.6°F (-2°C)	t ≥ -0.9°F (-0.5°C)	t ≤ -1.8°F (-1°C)	t ≥ 0°F (0°C)
	08	t < -3.6°F (-2°C)	t ≥ -0.9°F (-0.5°C)	t ≤ -3.6°F (-2°C)	t ≥ 0°F (0°C)
	09	t < -5.4°F (-3°C)	t ≥ -0.9°F (-0.5°C)	t ≤ -5.4°F (-3°C)	t ≥ 0°F (0°C)
	10	t < -7.2°F (-4°C)	t ≥ -0.9°F (-0.5°C)	t ≤ -7.2°F (-4°C)	t ≥ 0°F (0°C)
	11	t < -9.0°F (-5°C)	t ≥ -0.9°F (-0.5°C)	t ≤ -9.0°F (-5°C)	t ≥ 0°F (0°C)
	12	t < -5.4°F (-3°C)	t ≥ 0°F (0°C)	t ≤ -0.9°F (-0.5°C)	t ≥ -0.9°F (-0.5°C)
	13	t < -3.6°F (-2°C)	t ≥ 0°F (0°C)	t ≤ -1.8°F (-1°C)	t ≥ -0.9°F (-0.5°C)
	14	t < -3.6°F (-2°C)	t ≥ 0°F (0°C)	t ≤ -3.6°F (-2°C)	t ≥ -0.9°F (-0.5°C)
	15	t < -5.4°F (-3°C)	t ≥ 0°F (0°C)	t ≤ -5.4°F (-3°C)	t ≥ -0.9°F (-0.5°C)
	16	t < -7.2°F (-4°C)	t ≥ 0°F (0°C)	t ≤ -7.2°F (-4°C)	t ≥ -0.9°F (-0.5°C)
17	t < -9.0°F (-5°C)	t ≥ 0°F (0°C)	t ≤ -9.0°F (-5°C)	t ≥ -0.9°F (-0.5°C)	

### 6.3.1. Indoor unit indicator lamps

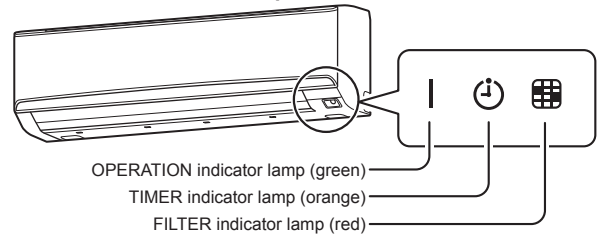

### 6.3.2. Checking the function settings

Press and hold the "MANUAL AUTO" button on the indoor unit for 3 seconds to check the function settings. It is necessary to disconnect the power in order to return to normal operation mode.

#### (1) Indoor unit and refrigerant address indication

##### Indication pattern

Indicator name	Indication pattern	
	Indoor unit address	Refrigerant address
OPERATION indicator lamp (Green)	ON	Flash (1.0s ON/1.0s OFF)
TIMER indicator lamp (Orange)	Address: tens place (0.5s ON/0.5s OFF)	
FILTER indicator lamp (Red)	Address: ones place (0.5s ON/0.5s OFF)	

##### Indoor unit address example (address: 24)

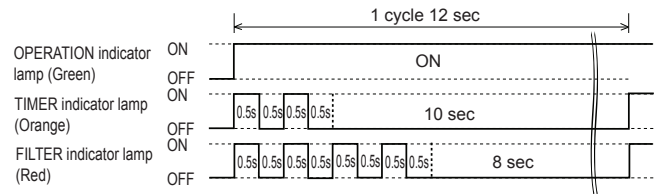

##### Refrigerant address example (address: 30)

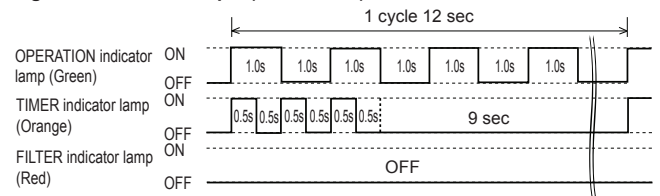

##### Setting details

Function number	Item	Setting number
01	Indoor unit address	00 to 63
02	Refrigerant address	00 to 99

For use with a remote controller, set all rotary switches to 0, and refer to "6.1. Setting the address" for details.

All switches are set to 0 at the factory.

#### (2) Others

##### Indication pattern

Indicator Name	Indication pattern
OPERATION indicator lamp (Green)	Function number; tens place (0.5s ON/0.5s OFF)
TIMER indicator lamp (Orange)	Function number; ones place (0.5s ON/0.5s OFF)
FILTER indicator lamp (Red)	Setting number: (0 to 9) (0.5s ON/0.5s OFF)

##### Example (function: 31, setting number: 2)

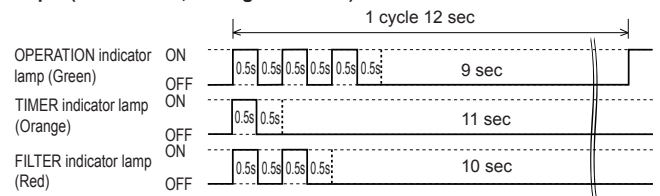

## 7. FINISHING

### ⚠ CAUTION

After checking for gas leaks (refer to the Installation Manual of the outdoor unit), perform this section.

Install heat insulation around both the large (gas) and small (liquid) pipes. Failure to do so may cause water leaks.

### 7.1. Connection pipe, cable and drain hose

Insulate the drain hose, if necessary, to prevent it from freezing.

(1) Insulate between pipes.

- For (A) Rear, (B) Right and (C) Bottom piping, overlap the connection pipe heat insulation and indoor unit pipe heat insulation and bind them with vinyl tape so that there is no gap.
- For (D) Left bottom piping, (E) Left piping, (F) Center piping and (G) Left rear piping, butt the connection pipe heat insulation and indoor unit pipe heat insulation together and bind them with vinyl tape so that there is no gap.

#### ((A) Rear, (B) Right and (C) Bottom piping)

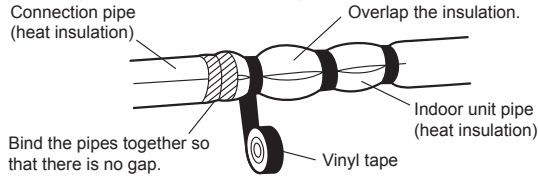

- (For (D) Left bottom piping, (E) Left piping, (F) Center piping and (G) Left rear piping)
- Wrap the area which accommodates the rear piping housing section with cloth tape.
- Bind the connection cable with vinyl tape.
- Bundle the piping and drain hose together by wrapping them with cloth tape over the range within which they fit into the rear piping housing section.

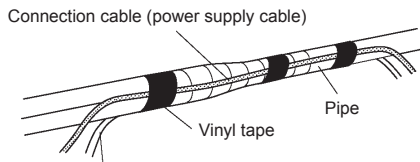
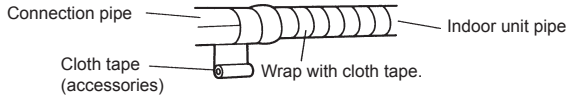

Connection cable (Transmission and Remote controller cable)

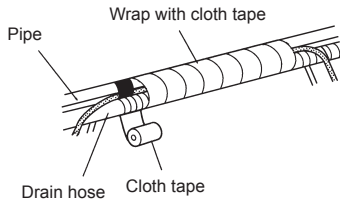

- Temporarily fasten the connection cable along the connection pipe with vinyl tape.
- Fasten the connection pipe to the outside wall with a saddle, etc.
- Fill the gap between the outside wall pipe hole and the pipe with sealer so that rain water and wind cannot blow in.
- Fasten the drain hose to the outside wall, etc.

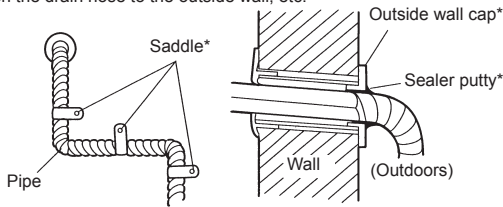

#### GOOD

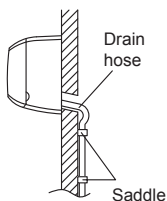

#### PROHIBITED

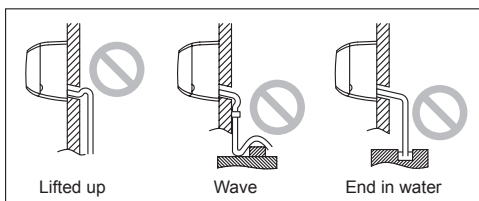

## 8. FRONT PANEL REMOVAL AND INSTALLATION

### 8.1. Intake grill removal and installation

#### Intake grill removal

Open the intake grille. While gently pressing the left and right mounting shafts of the intake grille outward "a", remove the intake grille in direction of the arrow "b".

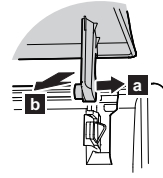

#### Intake grill installation

While holding the grille horizontal, set the left and right mounting shafts into the pillow blocks at the top of the panel "c". To latch each shaft properly, insert the shaft until it snaps.

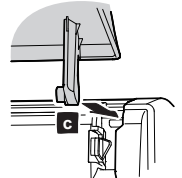

Press 4 places on the intake grille to close it completely.

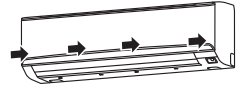

### 8.2. Front panel removal

- Remove 4 caps, remove wire cover and remove 10 screws.

#### NOTES:

When replacing the front panel, do not scratch or damage the louver.

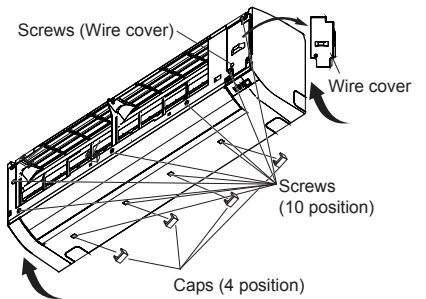

- The front panel is pulled to the front, raising the upper surface, then the front panel is removed.

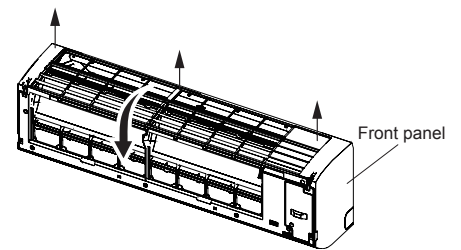

### 8.3. Front panel installation

- First, fit the lower part of the front panel, and insert top and middle hooks. (3 top sides, 5 middles)

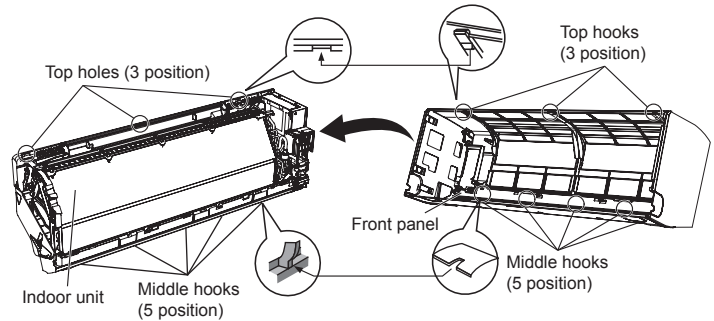

- Attach the 10 screws.
- Attach the wire cover.
- Attach the 4 caps.

## 9. TEST RUN

### 9.1. Test run using Outdoor unit (PCB)

Refer to the Installation Manual for the outdoor unit if the PCB for the outdoor unit is to be used for the test run.

### 9.2. Test run using remote controller

- Refer to the Installation Manual for the remote controller to perform the test run using the remote controller.
- When the air conditioner is being test run, the OPERATION and TIMER indicator lamp flash slowly at the same time.

## 10. CHECK LIST

Pay special attention to the check items below when installing the indoor unit(s). After installation is complete, be sure to check the following check items again.

Check items	If not performed correctly	Check box
Has the indoor unit been installed correctly?	Vibration, noise, indoor unit may drop	
Has there been a check for gas leaks (refrigerant pipes)?	No cooling, No heating	
Has heat insulation work been completed?	Water leakage	
Does water drain easily from the indoor units?	Water leakage	
Is the voltage of the power source the same as that indicated on the label on the indoor unit?	No operation, heat or burn damage	
Are the wires and pipes all connected completely?	No operation, heat or burn damage	
Is the indoor unit earthed (grounded)?	Short circuit	
Is the connection cable the specified thickness?	No operation, heat or burn damage	
Are the inlets and outlets free of any obstacles?	No cooling, No heating	
Does start and stop air conditioner operation by remote controller or external device?	No operation	
After installation is completed, has the proper operation and handling been explained to the user?	_____	

## 11. ERROR CODES

If you use a wired type remote controller, error codes will appear on the remote controller display. If you use a wireless remote controller, the lamp on the photodetector unit will output error codes by way of blinking patterns. See the lamp blinking patterns and error codes in the table below.

Error indications			Wired remote controller error code	Error contents
OPERATION lamp (green)	TIMER lamp (orange)	FILTER lamp (red)		
● (1)	● (2)	◇	12	Remote controller communication error
● (1)	● (4)	◇	14	Network communication error
● (1)	● (6)	◇	16	Peripheral unit communication error
● (2)	● (6)	◇	26	Indoor unit address setting error
● (2)	● (9)	◇	29	Connection unit number error in wired remote controller system
● (3)	● (1)	◇	31	Indoor unit power supply abnormal
● (3)	● (2)	◇	32	Indoor unit main PCB error
● (3)	● (10)	◇	3A	Indoor unit communication circuit (wired remote controller) error
● (4)	● (1)	◇	41	Indoor unit room temp. thermistor error
● (4)	● (2)	◇	42	Indoor unit heat ex. temp. thermistor error
● (4)	● (4)	◇	44	Human sensor error
● (5)	● (1)	◇	51	Indoor unit fan motor 1 error
● (5)	● (2)	◇	52	Indoor unit coil (expansion valve) error
● (5)	● (3)	◇	53	Indoor unit water drain abnormal
● (9)	● (15)	◇	9U	Outdoor unit miscellaneous error
● (10)	● (8)	◇	AB	Poor refrigerant circulation
● (13)	● (1)	◇	J1	RB unit error

Display mode ● : 0.5 s ON / 0.5 s OFF  
 ◇ : 0.1 s ON / 0.1 s OFF  
 ( ) : Number of flashing

### Wired Remote Controller Display

